

Instructions for use

MACH LED 115C / 115

Examination Light with LED Technology



Dr. Mach GmbH u. Co. KG, Flossmannstraße 28, D-85560 Ebersberg
Tel.: +49 (0)8092 2093 0, Fax +49 (0)8092 2093 50
Internet: www.dr-mach.com, E-mail: info@dr-mach.de

List of contents

1. Safety instructions	page 4
2. Brief description of the light Mach LED 115	page 7
3. Mounting instructions.....	page 8
3.1 Mounting the mobile stand.....	page 8
3.2 Mounting the light	page 9
3.3 Wall attachment.....	page 9
3.3.1 Wall attachment with additional extension arm (surcharge).....	Seite 9
3.4 Table attachment.....	page 10
3.5 Rail attachment	page 10
3.6 Round and rectangular tube attachment.....	page 10
3.7 Fixation of screw-on plate	page 10
4. Directions for use	page 11
4.1 Stand foot.....	page 11
4.2 Stand tube.....	page 11
4.3 Operating the light	page 12
4.3.1 ON/OFF switch	page 12
4.3.2 Positioning	page 12
4.3.3 Electronic light intensity control	page 13
4.3.4 Adjusting the colour temperature.....	page 13
5. Cleaning	page 14
5.1 Mobile stand.....	page 14
5.2 Light head.....	page 14
5.3 Protection disk.....	page 14
6. Maintenance.....	page 15
6.1 Periodical maintenance work.....	page 15
6.2 Settings at the light arm.....	page 15
6.3 Settings at the mobile stand	page 15
7. Data	page 16
7.1 Technical data	page 16
7.2 Electrical data.....	page 17
7.3 Technical data mobile stand	page 17
7.4 Information regarding the electrical installation	page 17
7.5 Weights	page 18
7.6 Environmental conditions.....	page 18
7.7 Important remarks	page 19
8. CE-mark.....	page 19
9. Disposal	page 19
10. Electromagnetic compatibility	page 20

Dear customer!

Congratulations for achieving our new OT-lamp **MACH LED 115C/115**.

The new light generation with LED technology supports your professionalism by innovative technology and design.

The advantages of the LED technology: adjustable light colour, a life-span of minimum 40.000 hours and an almost nonexistent heat development in the surgeon's head area and in the wound field.

The advantages already provided by Dr. Mach's light technology with halogen and gas discharge lamps have been maintained: natural colour reproduction, exact illumination of the wound field and easy positioning of the light head.

1. Safety instructions

Pay attention to the instructions for use when handling the lamp.

WARNING:

This device has not been designed for use in potentially explosive areas.
According to the Medical Device Regulation the light is classified under class I.

Store the OT-light in its package for at least 24 hours in the respective room before mounting, in order to equal temperature differences.

Please read the instructions for use carefully to make the most of your lighting system and to avoid any damages to the device.

The lights may only be repaired and special assembly work may only be carried out on the reflector or sockets by ourselves or a company that has been expressly authorized by us.

The manufacturer can only be made responsible for the safety of the light if repairs and alterations are carried out by the manufacturer himself or a company that guarantees to observe the safety regulations.



No modification of the lamp is allowed!

The manufacturer cannot be made liable for personal or material damages if the light is operated inexpediently or incorrectly or used for purposes other than those for which it is intended.

Make sure that the light is in perfect working order before every use.

General instructions

All Dr. Mach stand lamps are supplied with all installation and connection parts and components.

For packaging reasons, the five-foot stand is supplied in dismantled state. The stand tube is always assembled as a unit and only needs to be attached to the foot with the lower fastening screw.

The lamp is supplied with integrated connection lead and earthed plug.

The socket to be used for the lamp must be installed according to the requirements stipulated by the IEC or VDE 0100-710.

Please check that the earthed socket is available within the working area of the lamp.

Symbols and notes used in this user manual:



This symbol means possible hazard sources. Please observe also the safety remarks and the hazard specifications mentioned in the mounting instructions and user manuals from Ondal company.



This symbol means possible hazard caused by electric current. Please observe also the safety remarks and the hazard specifications mentioned in the mounting instructions and user manuals from Ondal company.



This symbol refers to important mounting indications, useful information and operation hints.

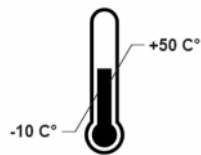

Temperature range for transport and storage



Indication for disposal

Symbols and notes used on the device:



This symbol indicates to observe the user manual.



Alternating current



Bulb

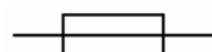

Fuse



Protective conductor

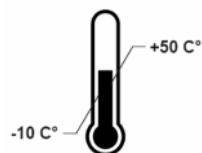

Temperature range for transport and storage



Indication for disposal



Serial number of the product



Article number of the product



Address of manufacturer / distributor of the product

2. Brief description of the light MACH LED 115C / 115

Mach LED 115C / 115 intended use:

The Mach LED 115C / 115 lighting system is designed for illuminating an examination area at the hospital and doctor's practice.

Mach LED 115C / 115 indications for use:

The surgical light MACH LED 115C/115 is intended to illuminate the surgical field and the patient's body with a high intensity, shadow-free and "cold" light.

Essential Performance:

The surgical light MACH LED 115C/115 are intended to provide the illumination in depth .

General product description

- The Mach LED 115C / 115 lighting system is an examination light according to EN 60601-2-41, which is not fail-safe when used as a single light.
- The light is designed to support diagnosis and treatment.
- The light is used in medical rooms (group 0, 1 and 2 according to DIN VDE 0100-710).
- The light can be mounted to the mobile stand, to the wall, to the table, to supply rails, to round and square tubes and with mounting plate.
- Maintenance of the light must be done every two years.
- The electrical connection is done with a patch cord.

The examination light Mach LED 115C / 115 is available in following versions:

- Mach LED 115C with light intensity control and colour temperature adjustment
- Mach LED 115 with light intensity control



Colour temperature adjustment is available only for LED 115C.

3. Mounting instructions

Extent of supply

- 1x 5-footed plastic central base
- 2x extension arms with blocking rollers
- 2x extension arms with electrically conductive rollers
- 1x extension arm with roller
- 1x cam catch plate
- 1x cheese head screw M8 with lock washer
- 1x stand tube
- Lamp head with arm
- Mounting instructions/Instructions for use – lamp head and stand

3.1 Mounting the mobile stand

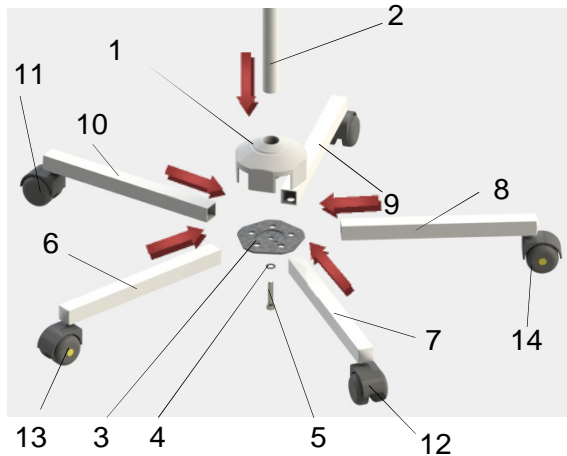

For mounting the stand proceed as follows:

- Place the central base **1** onto the stand tube $\text{Ø}25$ **2**. The stiffness is to ensure a tight fit that is free from any movement.
- Pre-mount the cam catch plate **3** (cams point inwards), with the lock washer **4** and cheese head screw M8 **5**, so that the extension arm **6** can still fit easily into the central base. Insert the extension arm **6** into the central base from above holding the cam catch plate **3** against from the opposite side.
- Insert the other 4 extension arms **7-10** in the sequence shown in the left figure into the central base. The extension arms are held by the cams of the cam catch plates.



Remark: Mount the two locking rollers **11** and **12**, and the two electrically conductive rollers **13** and **14** as shown in the figure (not next to each other).

- Tighten the catch plate with an Allen key SW6 (approx. 15Nm).
The cams of the catch plate must mate with the drill holes of the extension arms so that every extension arm is tightly fitted to both the central base and stand tube.
The cams also prevent the extension arms from being pulled out.

3.2 Mounting the light

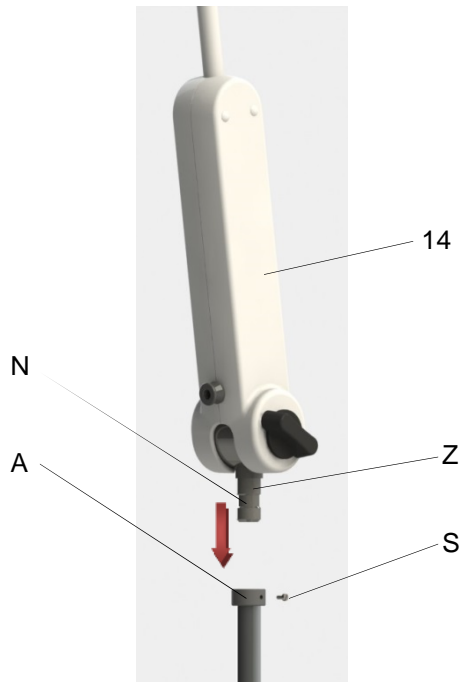

Tighten screw **S** in the mounting device (stand, wall, table, rail, round and rectangular tube, screw-on plate) after the lamp has been attached. This prevents the lamp from being unintentionally removed.



Make sure that joint **Z** at the lower side of transformer housing **14** is fully inserted into tube **A**, so that the safety screw **S** engages properly in the provided groove **N**.

3.3 Wall attachment

- Mark the position of the holes to be drilled in the wall using the wall bracket.
- Drill the holes and insert dowels provided by the customer. Dr. Mach does not include dowels in the scope of supply.
- For mounting the lamp see point 3.2.

3.3.1 Wall attachment with additional extension arm (option against surcharge)

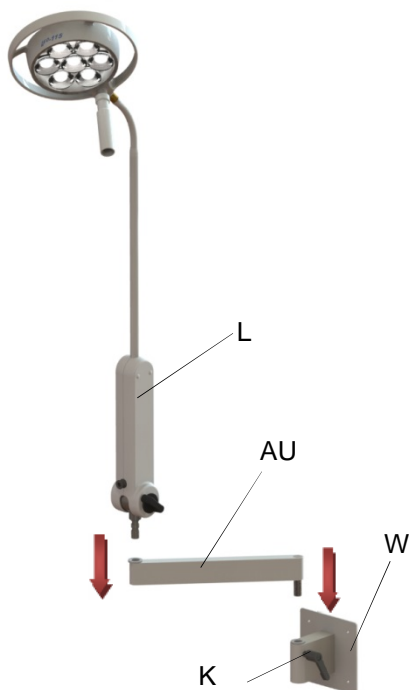

For the wall model of the lamp Mach LED 115 / 115C an additional extension arm can be ordered against surcharge. This extension arm increases the operating range of the lamp.

For mounting the extension arm proceed as follows:

- Mark the position of the holes to be drilled in the wall using the wall bracket **W**.
- Drill the holes and insert dowels provided by the customer. Dr. Mach does not include dowels in the scope of supply.
- Attach the extension arm **AU** to the wall bracket **W**.
- Attach the lamp **L** to the extension arm **AU**.

The position of the extension arm **AU** can be fixed with the clamping lever **K**.

3.4 Table attachment

- Screw table clamp onto table.
- For mounting the lamp see point 3.2.

3.5 Rail attachment

- Attach light mounting in the desired position on the rail.
- For mounting the lamp see point 3.2.

3.6 Round and rectangular tube attachment

- Screw light mounting in desired position onto tube.
- For mounting the lamp see point 3.2.

3.7 Attachment of screw-on plate

- Drill attachment holes and attach with screws.
- For mounting the lamp see point 3.2.

4. Directions for use

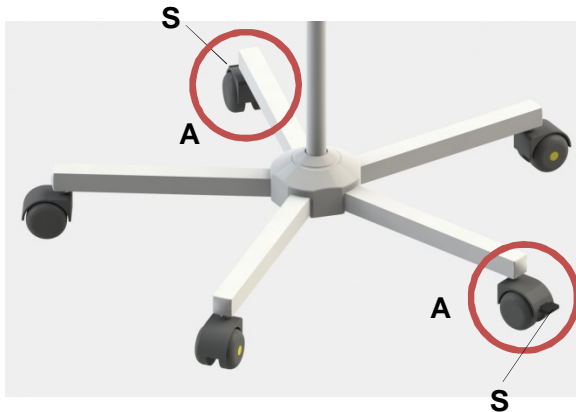

4.1 Stand foot

The five-foot stand is equipped with two opposing braked wheels **A**.



Set the brake by pressing the pedal **S** on the roller. Unlock by lifting the pedal again.

4.2 Stand tube



The stand tube can be adjusted continuously in height and fixed in the precisely required position, needing only one hand.

The height is adjusted by lifting the slip button **15**. The position of the light is automatically fixed on letting go.

As long as the slip button **15** is raised, the extension tube can be pulled off or inserted into the stand tube.

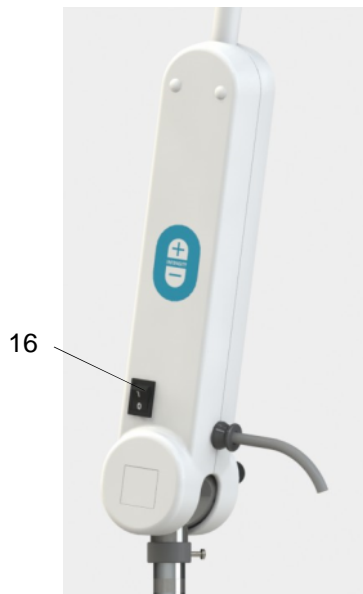

4.3 Operating the light

4.3.1 ON/OFF switch

Push the switch **16** on the power supply housing to switch the light on and off.

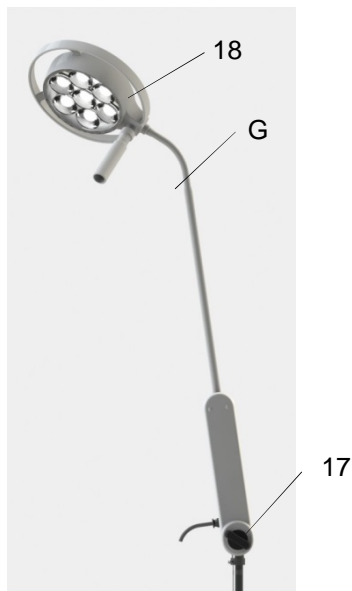

4.3.2 Positioning

Use the clamping lever **17** on the power supply housing to position the light arm.

Use the handle **18** on the light head to position the light.

The flexible joint **G** holds the light head in the requested position.



Attention !

It is not allowed to position the light in an angle below 90°. Otherwise the flexible tube can break.

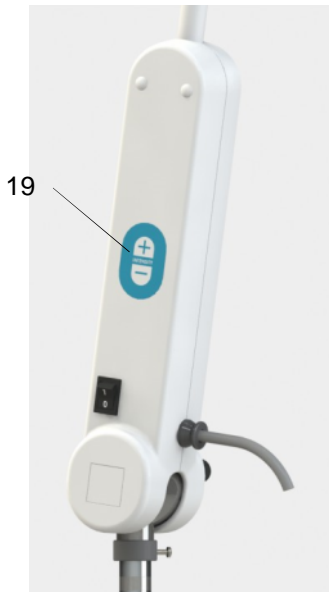

4.3.3 Electronic light intensity control

The light is supplied with an electronic light intensity control.

The light intensity can be adjusted and set at the key pad **19** on the power supply housing as follows:

- Pressing the key **Intensity +**: the light intensity increases;
- Pressing the key **Intensity -**: the light intensity decreases.

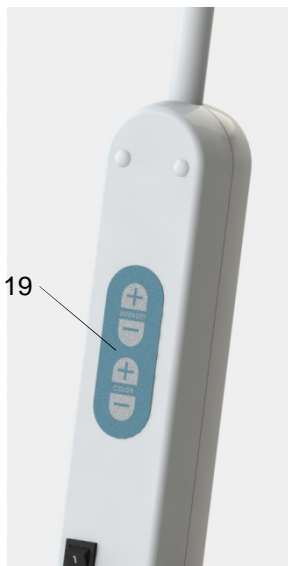
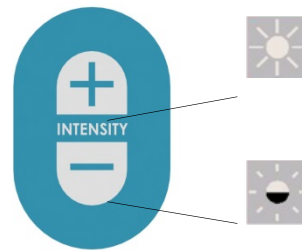

4.3.4 Adjusting the colour temperature (LED 115C only)

The light LED 115C is equipped with the function of colour temperature adjustment.

The following colour temperatures can be set: 3600K, 3900K and 4200K.

The colour temperature can be adjusted at the key pad **19** at the transformer housing as follows:

- Press the key **Colour +** to set a higher colour temperature;
- Press the key **Colour -** to set a lower colour temperature.

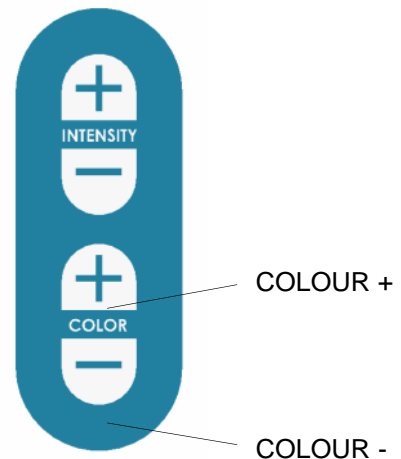

5. Cleaning

5.1 Mobile stand

The surface of the stands can be easily kept clean by simply wiping with a damp cloth. Conventional cleaning agents can be used.



5.2 Light head

The lamp has a high-quality surface, which can be cleaned with conventional cleaning agents.

5.3 Protection disk

The protection disk **20** is made of a high-quality plastic. Pay attention to the following during cleaning:

- Wipe over the protection disk **20** with a wet cloth (never use a dry cloth!).
- Wipe the protection disk **20** after cleaning with an antistatic, non-fluffy cloth.

6. Initial operation and maintenance

The light Mach LED 115C / 115 is equipped with a clamping lever on the power supply housing. After the mounting of the light with the mobile stand or the other fixation designs this clamping lever must be adjusted according to the customer's requirements.

Preventive maintenance of the light must be done every two years. This includes a technical and mechanical check-up.



Remark: Before doing any maintenance work on the light the light must be turned off and disconnected from mains. Please protect the light against switching on.

6.1 Activity at initial operation and maintenance Work

The following maintenance work / test has / have to be done:

- check on defects in paint work
- check on fissures at plastic parts
- check on deformation of the suspension
- check the connection between light and carrying system
- check the faultless function of the light
- perform the electrical safety tests

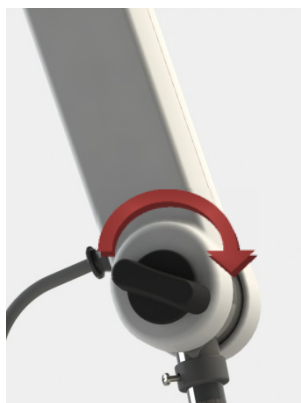

6.2 Settings at the light arm

◆ Adjusting the clamping lever

In case the movement of the light head is tight or it doesn't hold its position anymore, the braking efficiency of the clamping lever on the power supply housing must be adjusted.

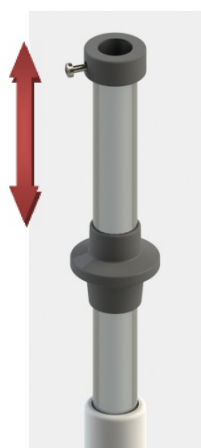

6.3 Settings at the mobile stand

◆ One-handed height adjustment

Adjusting the spring force at these stands is not possible.

It is usually not necessary to adjust the spring force at stands with one handed height adjustment.

7. Data

7.1 Technical data

	Mach LED 115C	Mach LED 115
Central light intensity at a distance of 0,5 meter	60.000 Lux	60.000 Lux
Central light intensity at a distance of 1 meter	14.000 Lux	14.000 Lux
Light field diameter d_{10} at a distance of 0,5 meters	103 mm	103 mm
Light field diameter d_{10} at a distance of 1 meter	228 mm	228 mm
Light field diameter d_{50} at a distance of 0,5 meters	60 mm	60 mm
Light field diameter d_{50} at a distance of 1 meter	103 mm	103 mm
Light intensity with one shadower	0 %	0 %
Light intensity with two shadowers	78 %	78 %
Light intensity on the ground of a normed tube	100%	100%
Light intensity on the ground of a normed tube with one shadower	0 %	0 %
Light intensity on the ground of a normed tube with two shadowers	78 %	78 %
Illumination depth 60 %	1180 mm	1180 mm
Colour rendering index R_a	95	95
Colour rendering index R_g	90	90
Max. radiation in field in a distance of 1 meter	51 W/m ²	51 W/m ²
Max. radiation in field in a distance of 0,30 meters	330 W/m ²	330 W/m ²
Light field size	10 cm	10 cm
Colour temperature (Kelvin)	3600/3900/4200 K	4000 K
Temperature increase in head area	0,5 °C	0,5 °C
Number of LED's	7	7
Life span of LED's	≥ 40.000 h	≥ 40.000 h
Light head diameter	22 cm	22 cm

Remark:

The technical data are subject to fluctuations. Due to manufacturing reasons the real values can slightly differ from the data mentioned above.

The values for R_a can differ with approx ± 5%.

The values for the colour temperature can differ with approx ± 200K.

7.2 Electrical data

	Mach LED 115C / 115
Power consumption	10 W
Operating voltage DC	24 V DC
Current	0,42 A

7.3 Technical data for the mobile stand

Lamp type		Mach 115C / 115
Data		
Stand foot	Number of extension arms	5
	Length of extension arms	310mm
	Rollers Ø	50mm
Stand tube	Approx. length.	95cm – 145cm
	Diameter	25mm
	Extension	yes
	Cable connection	no
	Suitable for article no.	115 310 1200
Arm + lamp head	Mounting	<ul style="list-style-type: none"> arm and Lamp head premounted arm mounted to stand

7.4 Information regarding the electrical installation

When turned ON, the OT-light MACH LED 115C / 115 is exposed to a current peak.
 The OT-light MACH LED 115C / 115 is delivered with a Dr. Mach power supply.

Warning!

The light is class I. equipment. In order to avoid the risk of an electric shock, the equipment must be connected to a mains supply with protective earth.

7.5 Weights

Light	Weight
Mach LED 115C / 115	6,0 kg*

* with 5-foot base

7.6 Environmental conditions

Operation

	Min.	Max.
Temperature	+10°C	+30°C*
Relative atmospheric humidity	30 %	75 %
Air pressure	700 hPa	1060 hPa

*In case of higher temperatures please contact us

Transport / storage

	Min.	Max.
Temperature	-10°C	+50°C
Relative atmospheric humidity	20 %	90 %
Air pressure	700 hPa	1060 hPa

References on the package

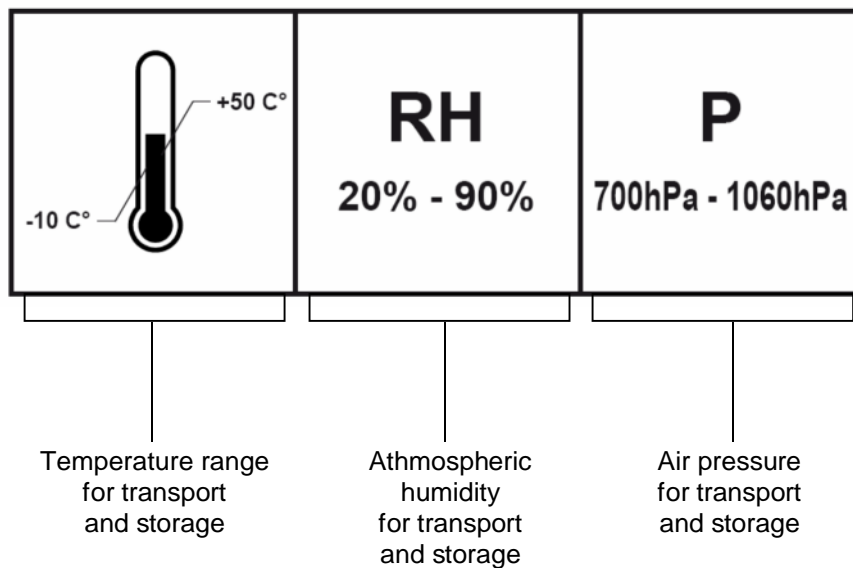

7.7 Important remarks



When using more than one lamp at the same time, due to the overlapping of the light fields of different lights, the total radiation intensity can exceed the value of 1000 W/m^2 . This means a risk of higher heat development in the wound field.

When using more than one lamp at the same time, due to the light fields overlapping of different lights the maximum permissible values for the UV-radiation ($< 400 \text{ nm}$) of 10 W/m^2 can be exceeded.



The test certificate for the electrical safety test can be requested when needed. Please provide the serial number of the respective light.

In case of a collective wiring of further lights or devices at installation, chapter 16 of the European standard EN 60601-1:2006 must be applied and eventually it has to be checked if the requirements are met.

The light must be tested according to EN 62353 at commissioning.

8. CE-mark



The products Mach LED 115C / 115 comply with the standards 93/42/EEC for medical products of the European Community's Council. Dr. Mach applies the standard EN 60601-2-41.
Dr. Mach GmbH is certified according to DIN EN ISO 13485:2012 + AC:2012.

9. Disposal



The OT-lamp doesn't contain any dangerous goods.
The components of the OT-lamp should be properly disposed at the end of its shelf-life. Make sure, that the materials are carefully separated.
The electrical conducting boards should be submitted to an appropriate recycling proceeding.
The rest of the components should be disposed according to the contained materials.

10. Electromagnetic compatibility

The Dr. Mach OT- and examination lights are subject to special preventive measures regarding the electromagnetic compatibility and must be installed according to the EMC-instructions mentioned in the accompanying documents.

The function of the OT- and examination lights can be affected by portable and mobile HF-communication devices.



The use of other equipment leads to an increased emission or to a reduced interference resistance of the device.



For the intended use of the OT-light MACH LED 115C/115 it is required that the light MACH LED 115C/115 is not mounted immediate and near to other devices or mounted together with other devices. If operating the light is obligatory near other devices or together with other devices, the functions of the light MACH LED 115C/115 must be observed.

Table 1 – Guidance and manufacturer’s declaration – electromagnetic emission – for all EQUIPMENT AND SYSTEMS

Guidance and manufacturer’s declaration – electromagnetic emission		
The MACH LED 115C / 115 is intended for use in the electromagnetic environment specified below. The customer or the user of the MACH LED 115C / 115 should assure that it is used in such an environment.		
Emissions test	Compliance	Electromagnetic environment - guidance
Harmonic emissions IEC 61000-3-2	Class A	The MACH LED 115C / 115 is suitable for use in all establishments, including domestic establishments and those directly connected to the public low-voltage power supply network that supplies buildings used for domestic purposes.
Voltage fluctuations / flicker emissions IEC 61000-3-3	Complies	
RF emissions CISPR 15	Complies	The MACH LED 115C / 115 is not suitable for interconnection with other equipment.

Table 2 – Guidance and manufacturer's declaration – electromagnetic immunity

Guidance and manufacturer's declaration – electromagnetic immunity			
The MACH LED 115C / 115 is intended for use in the electromagnetic environment specified below. The customer or the user of the MACH LED 115C / 115 should assure that it is used in such an environment.			
Immunity test	IEC 60601 test level	Compliance level	Electromagnetic environment - guidance
Electrostatic discharge (ESD) IEC 61000-4-2	± 6 kV contact ± 8 kV air	± 6 kV contact ± 8 kV air	Floors should be wood, concrete or ceramic tile. If floors are covered with synthetic material, the relative humidity should be at least 30 %.
Electrical fast transient / burst IEC 61000-4-4	± 2 kV for power supply lines ± 1 kV for input/output lines	± 2 kV for power supply lines not applicable	Mains power quality should be that of a typical commercial or hospital environment.
Surge IEC 61000-4-5	± 1 kV differential mode ± 2 kV common mode	± 1 kV differential mode ± 2 kV common mode	Mains power quality should be that of a typical commercial or hospital environment.
Voltage dips, short interruptions and voltage variations on power supply input lines IEC 61000-4-11	< 5 % U_T (>95 % dip in U_T) for 0,5 cycle 40 % U_T (60 % dip in U_T) for 5 cycles 70 % U_T (30 % dip in U_T) for 25 cycles < 5 % U_T (>95 % dip in U_T) for 5 sec	< 5 % U_T (>95 % dip in U_T) for 0,5 cycle 40 % U_T (60 % dip in U_T) for 5 cycles 70 % U_T (30 % dip in U_T) for 25 cycles < 5 % U_T (>95 % dip in U_T) for 5 sec	Mains power quality should be that of a typical commercial or hospital environment. If the user of the MACH LED 115C / 115 requires continued operation during power mains interruptions, it is recommended that the MACH LED 115C / 115 be powered from an uninterruptible power supply or a battery.
Power frequency (50/60 Hz) magnetic field IEC 61000-4-8	3 A/m	30 A/m	Power frequency magnetic fields should be at levels characteristic of a typical location in a typical commercial or hospital environment.
NOTE	U_T is the a. c. mains voltage prior to application of the test level.		

Table 4 – Guidance and manufacturer’s declaration – electromagnetic immunity – for EQUIPMENT and SYSTEM that are not LIFE-SUPPORTING

Guidance and manufacturer’s declaration – electromagnetic immunity			
The MACH LED 115C / 115 is intended for use in the electromagnetic environment specified below. The customer or the user of the MACH LED 115C / 115 should assure that it is used in such an environment.			
Immunity test	IEC 60601 test level	Compliance level	Electromagnetic environment - guidance
Conducted RF IEC 61000-4-6	3 V 150 kHz to 80 MHz	3 V	<p>Portable and mobile RF communications equipment should be used no closer to any part of the MACH LED 115C / 115 including cables, than the recommended separation distance calculated from the equation applicable to the frequency of the transmitter.</p> <p>Recommended separation distance</p> $d = 1,17\sqrt{P}$
Radiated RF IEC 61000-4-3	3 V/m 80 MHz to 2,5 GHz	3 V/m	$d = 1,17\sqrt{P}$ 80 MHz to 800 MHz $d = 2,34\sqrt{P}$ 800 MHz to 2,5 GHz <p>where p is the maximum output power rating of the transmitter in watts (W) according to the transmitter manufacturer and d is the recommended separation distance in metres (m).^b</p> <p>Field strengths from fixed RF transmitters, as determined by an electromagnetic site survey,^a should be less than the compliance level in each frequency range.^b</p> <p>Interference may occur in the vicinity of equipment marked with the following symbol:</p> 

NOTE 1 At 80 MHz and 800 MHz, the higher frequency range applies.

NOTE 2 These guidelines may not apply in all situations. Electromagnetic is affected by absorption and reflection from structures, objects and people.

^a Field strengths from fixed transmitters, such as base stations for radio (cellular/cordless) telephones and land mobile radios, amateur radio, AM and FM radio broadcast and TV broadcast cannot be predicted theoretically with accuracy. To assess the electromagnetic environment due to fixed RF transmitters, an electromagnetic site survey should be considered. If the measured field strength in the location in which the MACH LED 115C / 115 is used exceeds the applicable RF compliance level above, the MACH LED 115C / 115 should be observed to verify normal operation. If abnormal performance is observed, additional measures may be necessary, such as reorienting or relocating the MACH LED 115C / 115.

^b Over the frequency range 150 kHz to 80 MHz, field strengths should be less than 3 V/m.

Table 6 – Recommended separation distances between portable and mobile RF communications equipment and the EQUIPMENT or SYSTEM - for EQUIPMENT and SYSTEMS that are not LIFE-SUPPORTING

Recommended separation distances between portable and mobile RF communications equipment and the MACH LED 115C / 115			
The MACH LED 115C / 115 is intended for use in an electromagnetic environment in which radiated RF disturbances are controlled. The customer or the user of the MACH LED 115C / 115 can help prevent electromagnetic interference by maintaining a minimum distance between portable and mobile RF communications equipment (transmitters) and the MACH LED 115C / 115 as recommended below, according to the maximum output power of the communications equipment			
Rated maximum output of transmitter W	Separation distance according to frequency of transmitter m		
	150 kHz to 80 MHz $d = 1,17\sqrt{P}$	80 MHz to 800 MHz $d = 1,17\sqrt{P}$	800 MHz to 2,5 GHz $d = 2,34\sqrt{P}$
0,01	0,12	0,12	0,23
0,1	0,37	0,37	0,74
1	1,17	1,17	2,33
10	3,69	3,69	7,38
100	11,67	11,67	23,33
<p>For transmitters rated at a maximum output power not listed above the recommended separation distance d in meters (m) can be estimated using the equation applicable to the frequency of the transmitter, where P is the maximum output power rating of the transmitter in watts (W) according to the transmitter manufacturer.</p> <p>NOTE 1 At 80 MHz and 800 MHz, the separation distance for the higher frequency range applies.</p> <p>NOTE 2 These guidelines may not apply in all situations. Electromagnetic propagation is affected by absorption and reflection from structures, objects and people.</p>			